

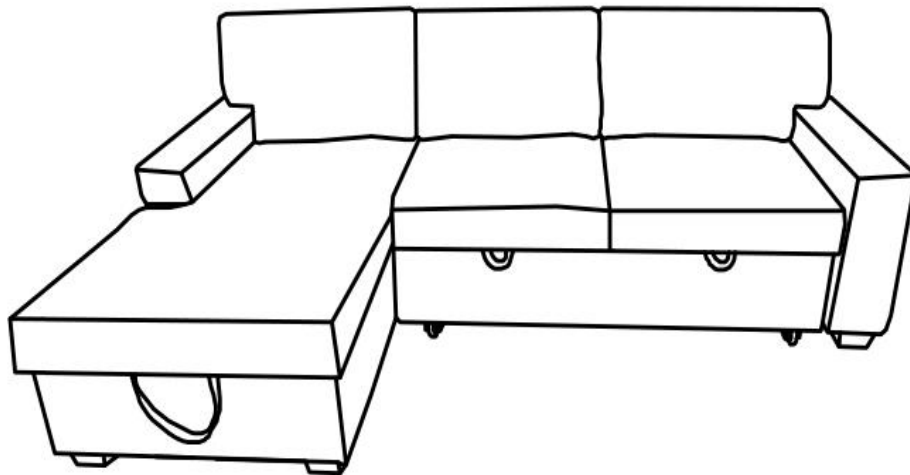









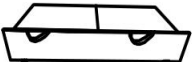

# ASSEMBLY INSTRUCTIONS

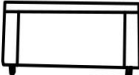
## Lucena Pull Out Reversible Sleep Sectional

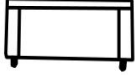

### Parts List

A		Loveseat Body	1pc	H		RSF Cushion	1pc
B		Chaise Body	1pc	I		Middle Cushion	1pc
C		Pull out seat Frame	1pc	J		LSF Cushion	1pc
D		Back Board of Loveseat	2 pcs	K		Square Foots	6pcs
E		Back Board of Chaise	1pc	L		Washer	7pcs
F		Arm of Loveseat	1pc	M		Plastic foot	1pc
G		Arm of Chaise	1pc				

Step 1: Align the hole positions, turn on the square feet, and don't forget turn on the mid-foot at the side of the chaise.

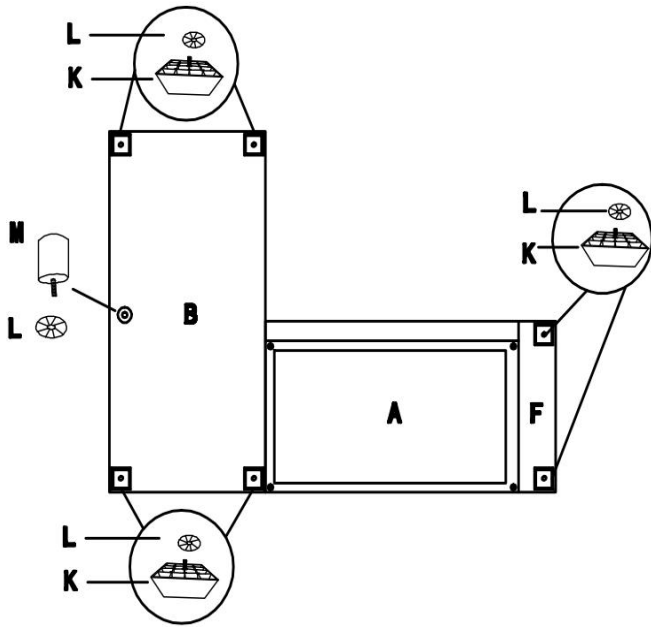

Step 2, align the hole, insert the board into the back side of sofa. Attach the arm to the right side of sofa with the brackets.

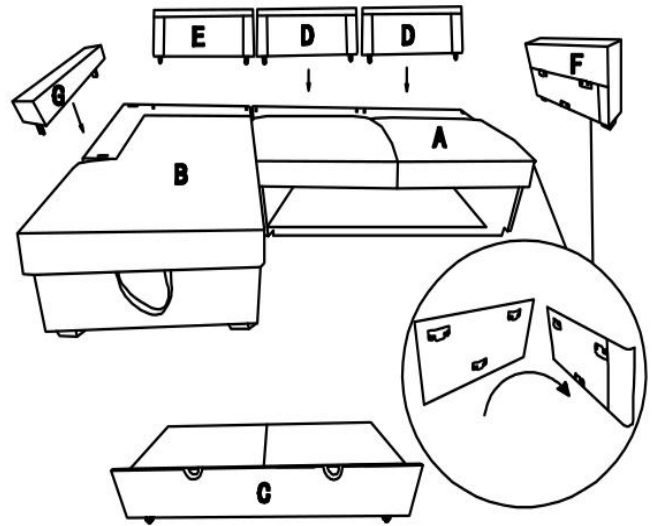

Step 3: Connect the Sofa and Chaise body with plates.

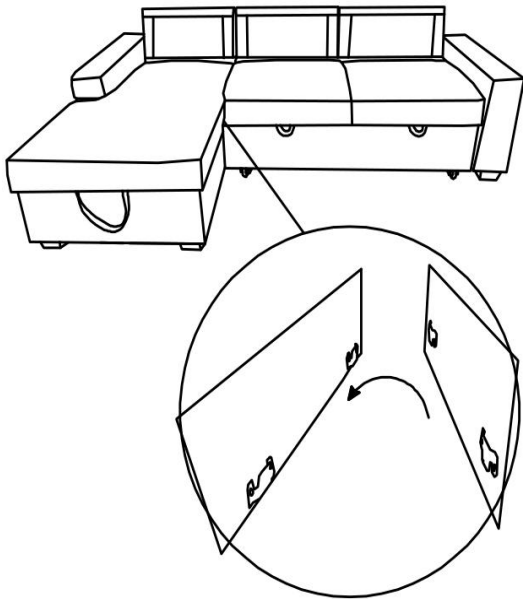

Step 4: Put on and tidy the cushion to the Sofa/Chaise.

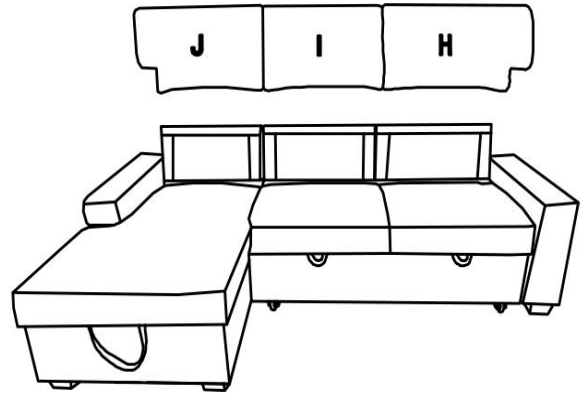

Step 5: Pull out the belt of the loveseat, can be use in bed.

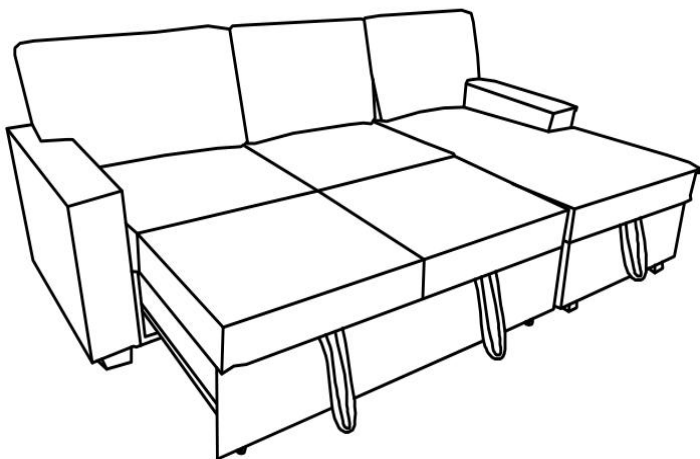

Step 4: Lift up of the belt of the chaise, can be storage.

